

Opening & safety sensor for automatic sliding doors

(according to EN 16005 and DIN 18650,
including emergency exits)

User's Guide for product version 0403 and higher
See product label for serial number

DESCRIPTION

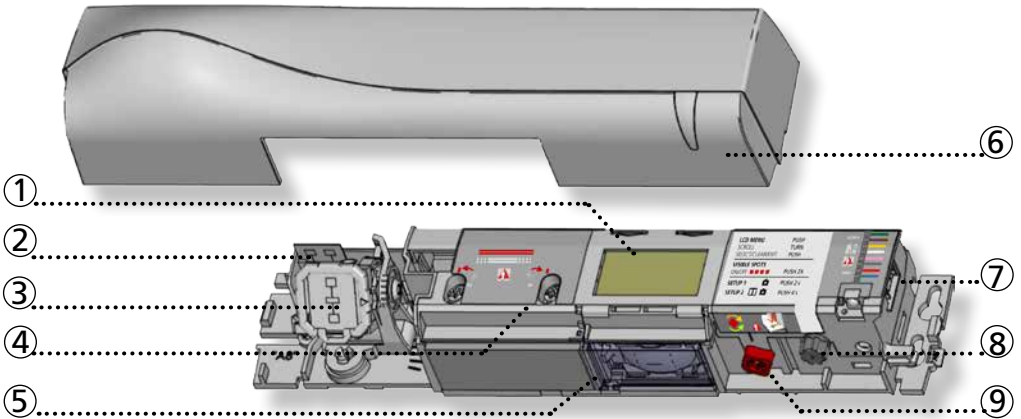

- | | |
|---------------------------------|-------------------------------------|
| 1. LCD | 6. cover |
| 2. radar antenna (narrow field) | 7. main connector |
| 3. radar antenna (wide field) | 8. main adjustment knob |
| 4. IR-curtain width adjustment | 9. IR-curtain angle adjustment knob |
| 5. IR-lenses | |

ACCESSORIES



Spotfinder



Remote Control

HOW TO USE THE LCD?

DISPLAY DURING NORMAL FUNCTIONING

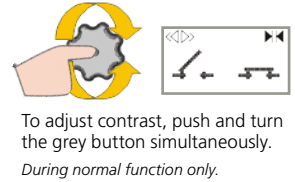
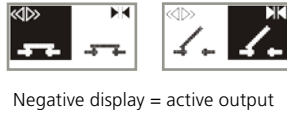
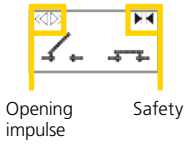

FACTORY VALUE VS. SAVED VALUE

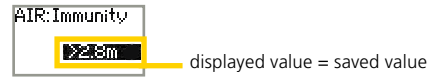
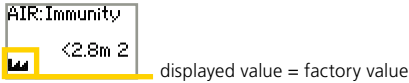

NAVIGATING IN MENUS

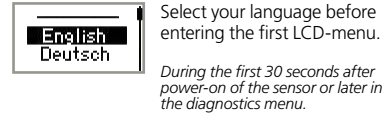
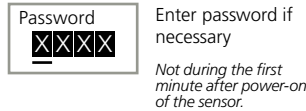
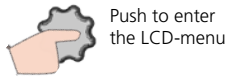

CHANGING A VALUE

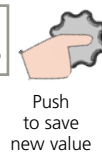
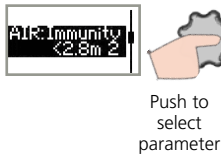

CHANGING A ZIP CODE

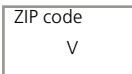

Validate the last digit in order to activate the new ZIP code:
- v = valid ZIP code, values will be changed accordingly
- x = invalid ZIP code, no values will be changed
- v/x = valid ZIP code, but from a different product.
Only available values will be changed.

VALUE CHECK WITH REMOTE CONTROL



Pressing a parameter symbol on your remote control, displays the saved value directly on the LCD-screen.
Do not unlock first.

1 MOUNTING & WIRING

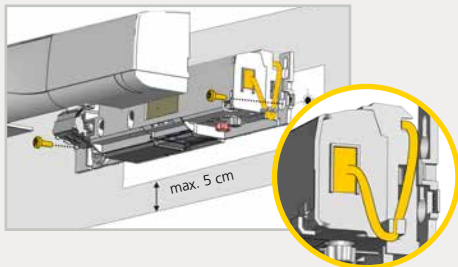

Fixation is compatible with the PASAM24T

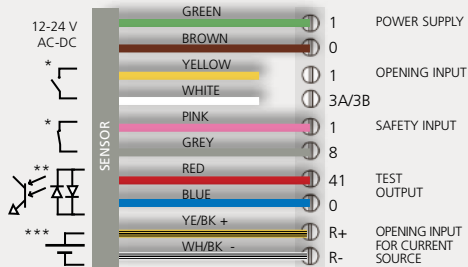

- * Output status when sensor is operational
- ** For compliance with EN 16005 and DIN 18650, connection to door controller test output is required.
- ***Current source output for emergency exits

2 RADAR OUTPUT CONFIGURATION

RELAY OUTPUT

NO: normally open

NC: normally closed



OR

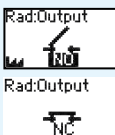

FREQUENCY OUTPUT

for emergency exits



CURRENT SOURCE OUTPUT

for emergency exits

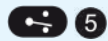
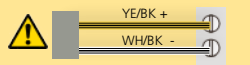

3 RADAR OPENING IMPULSE FIELD

ANGLE

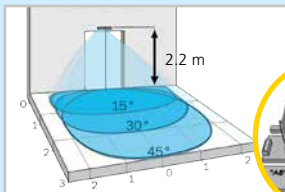

field size: 9
immunity: 2

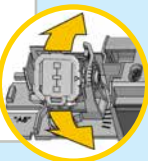

from 15° to 45°, default 30°

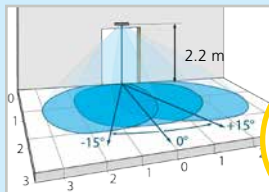

field size: 9
immunity: 2

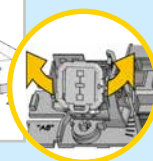

from -15° to 15°, default 0°

WIDTH

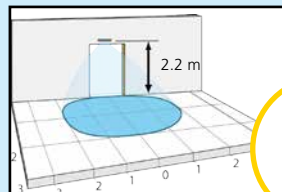

field size: 9
immunity: 2

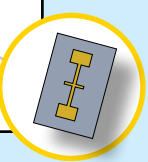

4 m x 2 m (wide)

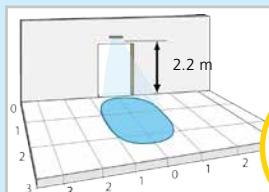

field size: 9
immunity: 2

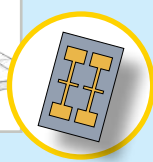

2 m x 2.5 m (narrow)

The size of the detection field varies according to the mounting height of the sensor.

In emergency exits the full door width must be covered.

4 INFRARED SAFETY FIELD

ANGLE

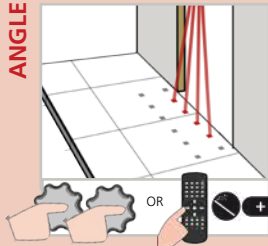

Activate the visible* spots to verify the position of the IR-curtain.

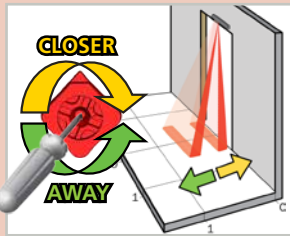

If necessary, adjust the IR-curtain angle (from -7° to 4° , default 0°).

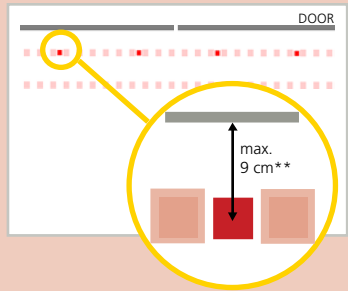

* Visibility depends on external conditions. When spots are not visible, use the Spotfinder to locate the curtains.
 ** The distance between the inner curtain of the inside door sensor and the inner curtain of the outside door sensor should always be smaller than 20 cm. The distance to the door leaf depends therefore on the thickness of the door leaf.

WIDTH

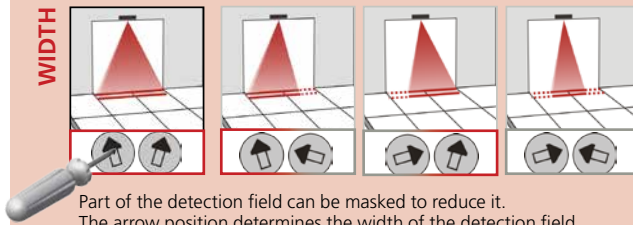

Part of the detection field can be masked to reduce it. The arrow position determines the width of the detection field.



Additional adjustments are possible by LCD or remote control (see p. 5)

Always verify the actual detection field width with a piece of paper and not the Spotfinder, which detects the whole emitted field.

Mounting height	Detection width
2.00 m	2.00 m
2.20 m	2.20 m
2.50 m	2.50 m
3.00 m	d max
3.50 m	d max

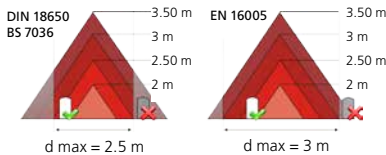

The size of the detection field varies according to the mounting height and the settings of the sensor. The full door width must be covered.

5 SETTINGS

Choose one of the following presettings or adjust the sensor manually (see p.5):

STANDARD: standard in- and outdoor installations

CRITICAL ENVIRONMENT: critical installations due to surroundings or weather

SHOPPING STREET: installations in narrow streets with pedestrian traffic

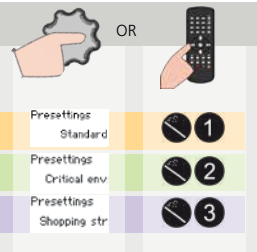

6 SETUP

STEP OUT OF THE INFRARED FIELD!

SETUP 1 (QUICK)

reference picture



SETUP 2 (ASSISTED)

test of full door cycle + reference picture























TEST THE GOOD FUNCTIONING OF THE INSTALLATION BEFORE LEAVING THE PREMISES!

OVERVIEW OF SETTINGS

	0	1	2	3	4	5	6	7	8	9		
<div style="display: flex; align-items: center;"> <div style="margin-right: 10px;"> </div> <div> <p>Back</p> <p>More</p> </div> </div>												
PRESETTINGS		standard	critical env.	shopping street	factory values for radar immunity, IR immunity, IR number and redirection increased immunities, 1 curtain increased immunities, redirection = motion and presence							
RAD: FIELD SIZE	small	>	>	>	>	>	>		>	large		
RAD: OUTPUT	NO NC	NC NO	NC NO	NC NO	NO NC	current NC	freq NC	NO: normally open NC: normally closed	freq: frequency output current: current output			
IR: IMMUNITY			↑ < 2.8 m				↓ > 2.8 m	For conformity to EN 16005 or DIN 18650 at a mounting height of 2.8 or more, use values 6 and 7.				
IR: FREQUENCY	A	B	Sensors mounted close to each other should have a different frequency.					For conformity to BS 7036 at a mounting height of 2.2 m or more, use values 6 and 7.				
<div style="display: flex; align-items: center;"> <div style="margin-right: 10px;"> </div> <div> <p>More</p> <p>Back</p> </div> </div>	<div style="border: 1px solid black; padding: 5px;"> <p>excludes conformity of the door system according to EN 16005 / DIN 18650 / BS 7036</p> <p>not allowed when the sensor is used in emergency exits</p> </div>											
<div style="display: flex; align-items: center;"> <div style="margin-right: 10px;"> </div> <div> <p>Back</p> <p>More</p> </div> </div>	<div style="border: 1px solid black; padding: 5px;"> <p>factory value</p> </div>											
RAD: IMMUNITY		low		>	>	>	>	>	>	high		
RAD: DIRECTION	radar off	bi	uni	uni PRM	uni AWAY	bi auto	uni auto	PRM auto	PRM: for persons with reduced mobility AWAY: unidirectional motion away from sensor auto: automatic adaptation of field size (small shops)			
RAD: HOLD TIME	0.5 s	1 s	2 s	3 s	4 s	5 s	6 s	7 s	8 s	9 s		
IR: WIDTH											Always additionally adjust the arrow position on the sensor with a screwdriver.	
IR: NUMBER	service mode	1	2	service mode = no IR detection during 15 minutes (maintenance). This value excludes conformity of the door system to EN 16005 and DIN 18650.								
IR: PRESENCE TIME	motion	15 s	30 s	1 min	2 min	5 min	10 min	20 min	60 min	infinite	min. value for DIN18650: 1 min min. value for EN16005: 30 s	
IR: OUTPUT	NO NC	NC NO	NC NO	NC NO	NO NC	current NC	freq NC	NO: normally open NC: normally closed				
REDIRECTION	motion	motion or presence	motion and presence	opening output is active in case of:			0	motion detection motion or presence detection motion and presence detection				
FACTORY RESET									full reset	partial reset	partial: outputs are not reset	
<div style="display: flex; align-items: center;"> <div style="margin-right: 10px;"> </div> <div> <p>More</p> <p>Back</p> </div> </div>												
<div style="display: flex; align-items: center;"> <div style="margin-right: 10px;"> </div> <div> <p>Back</p> <p>More</p> </div> </div>												
ZIP CODE	all parameter settings in zipped format (see application note on ZIP CODE)										POWERSUPPLY	supply voltage at power connector
ID #	unique ID-number										OPERATINGTIME	power duration since first startup
ERROR LOG	last 10 errors + day indication										RESET LOG	delete all saved errors
IR: SPOTVIEW	view of spot(s) that trigger detection										PASSWORD	LCD and remotec control password (0000= no password)
IR: C1 ENERG	signal amplitude received on curtain 1										LANGUAGE	language of LCD-menu
IR: C2 ENERG	signal amplitude received on curtain 2										ADMIN	enter code to access admin mode

TROUBLESHOOTING

E1		ORANGE LED flashes 1 x.	The sensor signals an internal fault.	<ol style="list-style-type: none"> 1 Replace sensor.
E2		ORANGE LED flashes 2 x.	The power supply is too low or too high.	<ol style="list-style-type: none"> 1 Check power supply (in the diagnostics menu of the LCD). 2 Check wiring.
E4		ORANGE LED flashes 4 x.	The sensor receives not enough IR-energy.	<ol style="list-style-type: none"> 1 Decrease the angle of the IR-curtains. 2 Increase the IR-immunity filter (values >2.8 m). 3 Deactivate 1 curtain.
E5		ORANGE LED flashes 5 x.	The sensor receives too much IR-energy.	<ol style="list-style-type: none"> 1 Slightly increase the angle of the IR-curtains. 2 Decrease the IR-immunity filter (values 1-3 <2.8 m).
E5			The sensor is disturbed by external elements.	<ol style="list-style-type: none"> 1 Eliminate the cause of disturbance (lamps, rain cover, door controller housing properly grounded).
E6		ORANGE LED flashes 6 x.	Faulty radar sensor output	<ol style="list-style-type: none"> 1 Replace sensor.
E7		ORANGE LED flashes 7 x.	The internal test of the radar is disturbed.	<ol style="list-style-type: none"> 1 Change radar field angle or antenna. 2 Launch a quick setup. 3 If orange LED flashes again, replace sensor.
E8		ORANGE LED flashes 8 x.	IR power emitter is faulty.	<ol style="list-style-type: none"> 1 Replace sensor.
E9		ORANGE LED flashes 9 x.	Internal reference of the radar is faulty.	<ol style="list-style-type: none"> 1 Replace sensor.
		ORANGE LED is on.	The sensor encounters a memory problem.	<ol style="list-style-type: none"> 1 Cut and restore power supply. 2 If orange LED lights up again, replace sensor.
		RED LED flashes quickly after an assisted setup.	The sensor sees the door during the assisted setup.	<ol style="list-style-type: none"> 1 Move the IR-curtains away from the door. 2 Install the sensor as close to the door as possible. If needed, use a bracket accessory. 3 Launch a new assisted setup.
		RED LED lights up sporadically.	The sensor vibrates.	<ol style="list-style-type: none"> 1 Check if the sensor is fastened firmly. 2 Check position of cable and cover.
			The sensor sees the door.	<ol style="list-style-type: none"> 1 Launch an assisted setup and adjust the IR angle.
			The sensor is disturbed by external conditions.	<ol style="list-style-type: none"> 1 Increase the IR-immunity filter to value 3. 2 Select presetting 2 or 3.
		GREEN LED lights up sporadically.	The sensor is disturbed by rain and/or leaves.	<ol style="list-style-type: none"> 1 Select presetting 2 or 3. 2 Increase radar-immunity filter.
			Ghosting created by door movement.	<ol style="list-style-type: none"> 1 Change radar field angle.
			The sensor vibrates.	<ol style="list-style-type: none"> 1 Check if the sensor and door cover is fastened firmly. 2 Check position of cable and cover.
			The sensor sees the door or other moving objects.	<ol style="list-style-type: none"> 1 Remove the objects if possible. 2 Change radar field size or angle.
		The LED and the LCD-display are off.		<ol style="list-style-type: none"> 1 Check wiring.
		The reaction of the door does not correspond to the LED-signal.		<ol style="list-style-type: none"> 1 Check output configuration setting. 2 Check wiring.
		The LCD or remote control does not react.	The sensor is protected by a password.	<ol style="list-style-type: none"> 1 Enter the right password. If you forgot the code, cut and restore the power supply to access the sensor without entering a password during 1 minute.

LED-SIGNAL

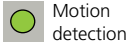

Motion detection



Presence detection

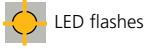

LED flashes

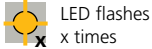

LED flashes
x times

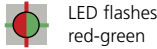

LED flashes
red-green

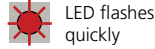

LED flashes
quickly



LED is off

INSTALLATION



The sensor should be fixed firmly to avoid extreme vibrations.



Do not cover the sensor.



Avoid moving objects and light sources in the detection field.



Avoid highly reflective objects in the infrared field.

MAINTENANCE



It is recommended to clean the optical parts at least once a year or more if required due to environmental conditions.



Do not use aggressive products to clean the optical parts.

SAFETY

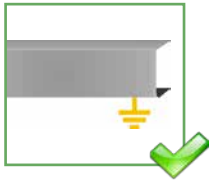

The door control unit and the door cover profile must be correctly earthed.



Only trained and qualified personnel may install and setup the sensor.



Always test the good functioning of the installation before leaving the premises.

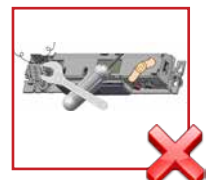

The warranty is invalid if unauthorized repairs are made or attempted by unauthorized personnel.



- The device cannot be used for purposes other than its intended use. All other uses cannot be guaranteed by the manufacturer of the sensor.
- The manufacturer of the door system is responsible for carrying out a risk assessment and installing the sensor and the door system in compliance with applicable national and international regulations and standards on door safety.
- The manufacturer of the sensor cannot be held responsible for incorrect installations or inappropriate adjustments of the sensor.

TECHNICAL SPECIFICATIONS

Supply voltage:	12 V - 24 V AC +/-10% ; 12 V - 30 V DC +/-10% (to be operated from SELV compatible power supplies only)
Power consumption:	< 2.5 W
Mounting height:	2 m to 3.5 m (local regulations may have an impact on the acceptable mounting height)
Temperature range:	-25°C to +55°C; 0-95% relative humidity, non condensing
Degree of protection:	IP54
Noise:	< 70 dB
Expected lifetime:	20 years



Detection mode:	Motion Min. detection speed: 5 cm/s	Presence Typical response time: < 200 ms (max. 500 ms)
Technology:	Microwave doppler radar Transmitter frequency: 24.150 GHz Transmitter radiated power: < 20 dBm EIRP Transmitter power density: < 5 mW/cm ²	Active infrared with background analysis Spot: 5 cm x 5 cm (typ) Number of spots: max. 24 per curtain Number of curtains: 2
Output:	Solid-state-relay (potential and polarity free) Max. contact current: 100 mA Max. contact voltage: 42 V AC/DC - in switching mode: NO/NC - in frequency mode: pulsed signal (f= 100 Hz +/- 10%) Galvanically isolated current source No detection: current source ON Open circuit voltage: 6.5 V Output voltage available at 10 mA: 3 V min. Typical load: up to 3 optocouplers in series Detection: current source OFF Open-circuit remained voltage: < 500 mV	Solid-state-relay (potential and polarity free) Max. contact current: 100 mA Max. contact voltage: 42 V AC/DC Holdtime: 0.3 to 1 s
Test input:		Sensitivity: Low: < 1 V; High: > 10 V (max. 30 V) Response time on test request: typical: < 5 ms
Norm conformity:	EN 12978 EN ISO 13849-1 EN 16005 Chapter 4.6.8; DIN 18650-1 Chapter 5.7.4; AutSchR BS 7036-1 Chapter 7.3.2 (only applicable for relay output in frequency mode and current source output)	EN 12978 EN ISO 13849-1 PL «c» CAT. 2 (under the condition that the door control system monitors the sensor at least once per door cycle) IEC 61496-1 ESPE Type 2 EN 16005 Chapter 4.6.8; DIN 18650-1 Chapter 5.7.4 BS 7036-1 Chapter 8.1



Specifications are subject to changes without prior notice.
All values measured in specific conditions.

ENTREMATIC Entrematic Group AB - Lodjursgatan 10 - SE-261 44 Landskrona - Sweden - www.entrematic.com



Entrematic Group AB, Lodjursgatan 10, SE-261 44 Landskrona, Sweden, hereby declares that the Entrematic PAS024AMT is in conformity with the basic requirements and the other relevant provisions of the directives 2014/53/EU, 2011/65/EU and 2006/42/EC.

Notified Body for EC-type inspection: 0044 - TÜV NORD CERT GmbH, Langemarkstr. 20, D-45141 Essen

EC-type examination certificate number: 44 205 12 405836-001

Landskrona, September 2016 Marco Pietro Zini, authorized representative and responsible for technical documentation

The complete declaration of conformity is available on our website.



Only for EC countries: According to the European Guideline 2012/19/EU for Waste Electrical and Electronic Equipment (WEEE)